



USG BORAL HIGHLANDS™ CEILING SYSTEM

Technical Manual (Installation Guide)

The USG Boral Highlands™ Ceiling System provides customised ceiling visual effects with multiple perforation patterns and panel height options. The Highlands™ ceiling panels can be easily installed or removed, offering access to the plenum.



USGBoral.com

Gypsum Boards

Ceilings

Compounds

Metal Framing

Substrates

USG BORAL HIGHLANDS™ CEILING SYSTEM

Safety First!

Follow good safety and industrial hygiene practices during installation. Wear appropriate personal protective equipment.

Installation

All ceiling products and systems must be installed and maintained in accordance with current USG Boral written instructions and best industry practice, including the CISCA Handbook, ASTM C636, and standard industry practices, within all applicable code requirements. Alternative assemblies and installation methods may be utilised when approved by the Authority Having Jurisdiction. USG Boral recommends checking with the Authority Having Jurisdiction prior to designing and installing a suspended ceiling system. Because codes continue to evolve, check with a local official prior to designing and installing a ceiling system. Other restrictions and exemptions may apply.

Notice

We shall not be liable for incidental and consequential damages, directly or indirectly sustained, nor for any loss caused by application of these goods not in accordance with current printed instructions or for other than the intended use. Our liability is expressly limited to replacement of defective goods. Any claim shall be deemed waived unless made in writing to us within thirty (30) days from date it was or reasonably should have been discovered.

System Components - Supplied by USG Boral

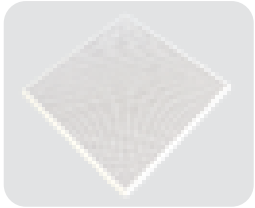

Ceiling panel

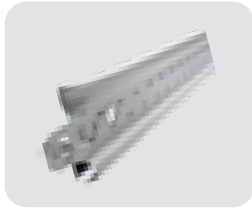

Cross runner

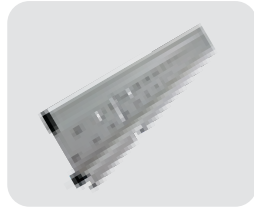

Main runner



Runner bracket

System Components - Supplied by Installer

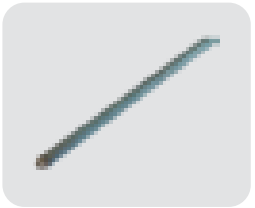

Galvanised M6 threaded rod



Galvanised M6 nut

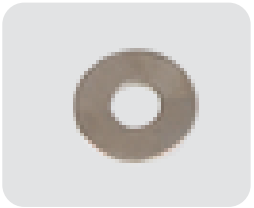

Galvanised M6 washer



Galvanised M6 self tapping screw

Tools Required for Installation



Cordless drill/driver



6mm rotary masonry drill bit



Phillips head #2 screwdriver bit

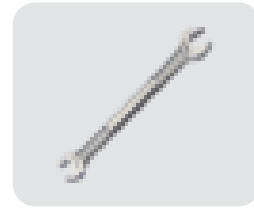

10mm open ended wrench

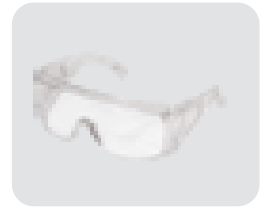

Safety glasses



Work gloves

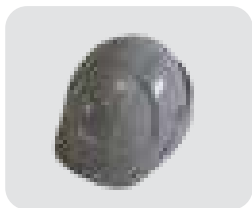

Safety helmet

General Arrangement Drawing of Suspension System

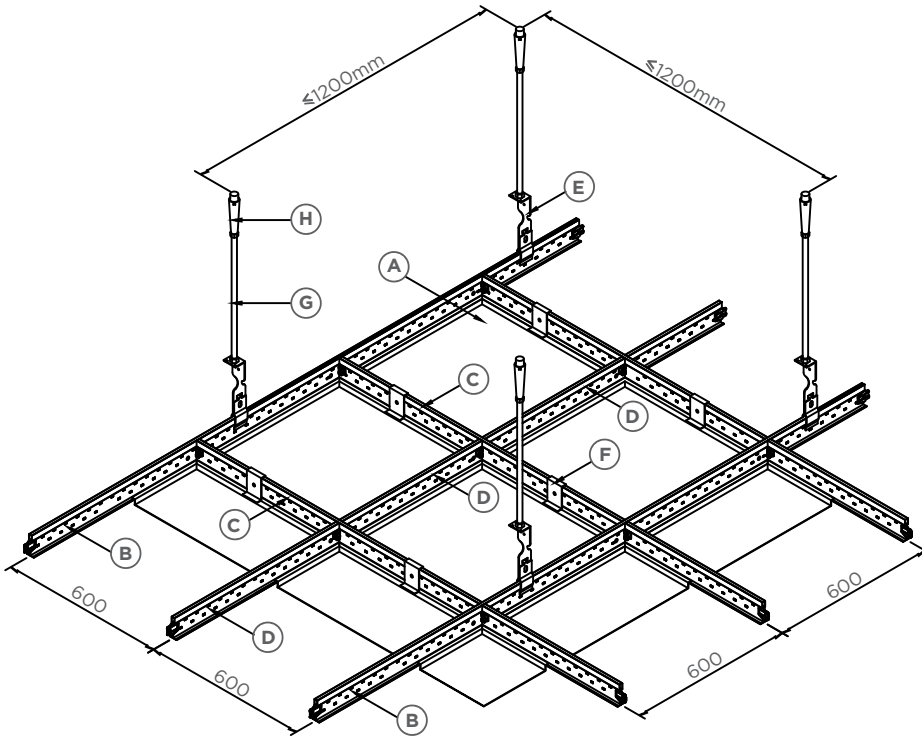

Item	Description
A	Lay-in panel
B	Main runner (3.0m)
C	Cross runner (1.2m)
D	Cross runner (0.6m)
E	Runner bracket
F	Security clip
G	Threaded rod
H	Anchor bolt

Step by Step Installation Instruction



Step 1

Put on personal protective equipment.

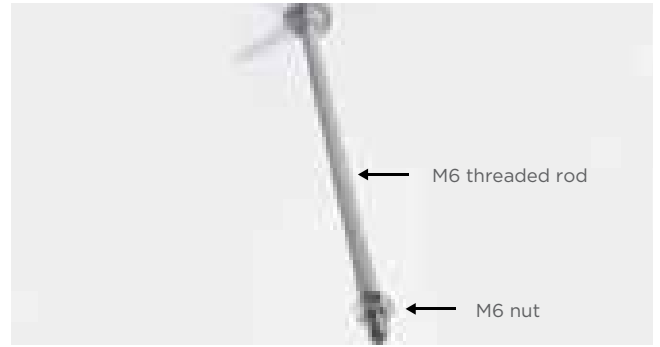

Step 2

Ensure M6 threaded rod is securely mounted to the concrete ceiling. Insert M6 nut for Runner bracket.



Step 3

Insert Runner bracket. Secure with M6 washer and nut on the top and bottom of the bracket as shown.



Step 4

Insert Main runner into Runner bracket. Ensure Main runner and Runner bracket are both level.



Step 5

Tighten screw on Runner bracket clamp. Ensure Main runner is securely attached to Runner bracket.



Step 6

Insert Cross runners perpendicular to Main runner. Ensure Cross runners are inserted until it locks with a click.

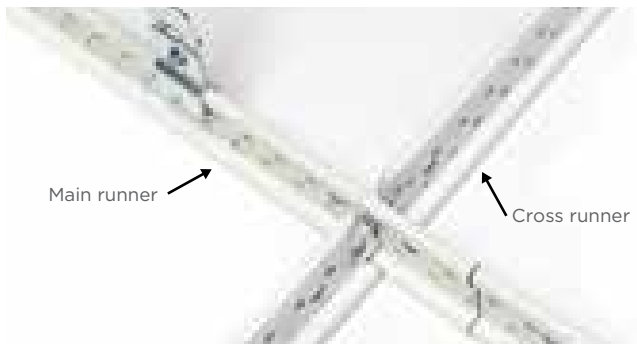

Step 7

Install remaining Cross runners and Main runners to create a frame for the ceiling panels.

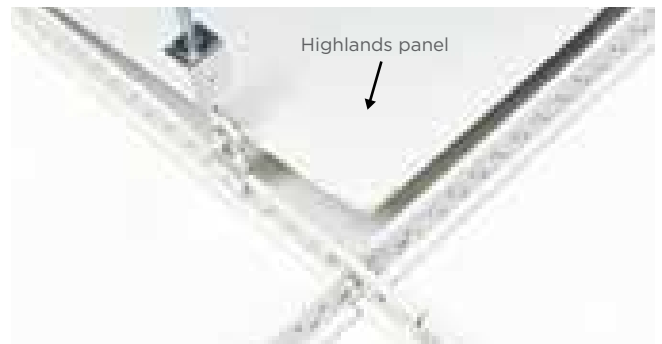

Step 8

Install a Highlands panel onto the runner frame.



Step 9

Ensure panels sit flush on the runners. Install remaining panels in accordance with the ceiling layout.

Australia
China
India
Indonesia
Malaysia
Middle East
New Zealand
Philippines
Singapore
South Korea
Thailand
Vietnam

3rd Floor 108 Central Building A
108 E. Rodriguez Jr. Avenue, Bagumbayan,
Quezon City, Philippines 1110
T: +63 2 911 6709 | F: +63 2 911 6709 ext. *98
info.ph@usgboral.com